

THE KIRI & THE CHENEY

Engineered Stone Countertop Basins

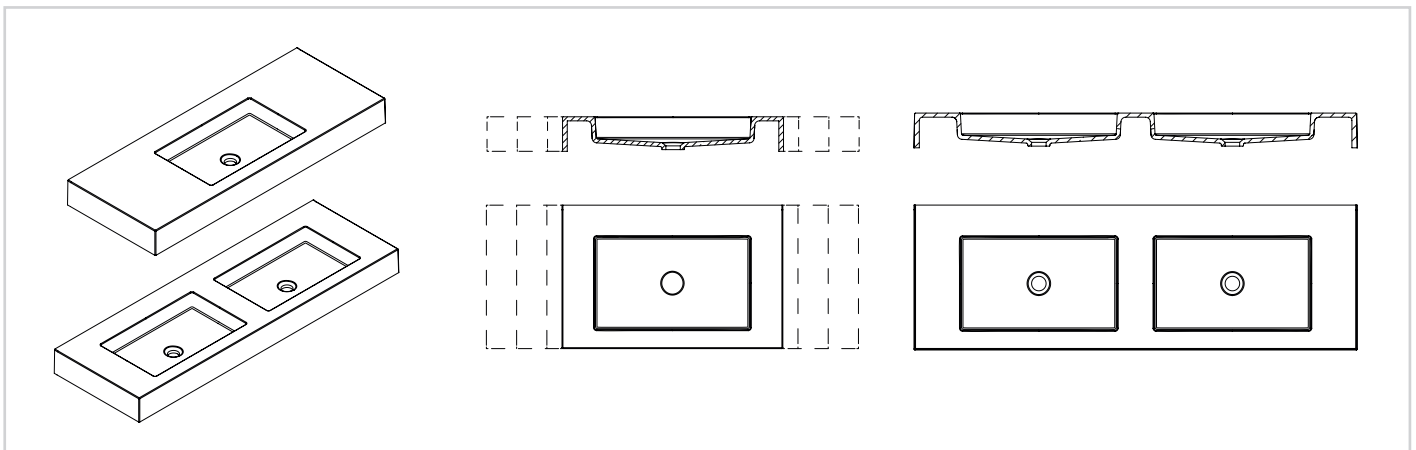
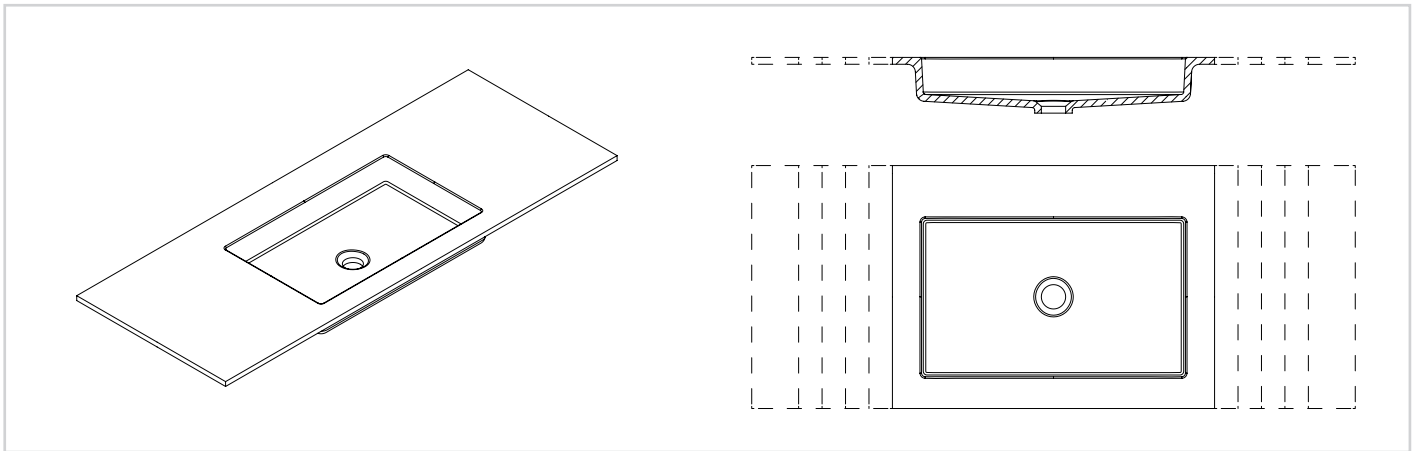

IMPORTANT INFORMATION BEFORE YOU START

Please read carefully and keep this information for further reference.

Thank you for buying a Clearwater Product. To ensure that it works to its full potential, it needs to be fitted correctly. Check the contents of the pack carefully before installation.

Bathroom Brands will not be held responsible for any de-fit/ re-fit costs where faulty product has been fitted. If any fault is found with materials or workmanship, it must be reported immediately to the manufacturer. Remedial action will be taken, based on information received, on condition that:

1. Full details are supplied to the manufacturer.
2. The product has not been modified or tampered with;
3. The manufacturer is informed of any damage/shortages prior to installation.
4. The product has not been installed, or attempts have been made to install.

We do not accept responsibility for any problems that may occur through incorrect installation. This product should only be installed by a suitably qualified plumber/installer.

Should the installation be completed by a non-qualified person any product guarantee maybe considered invalid. For a claim made under our warranty, written certification of your installer's qualifications may be required.

BEFORE YOU START

Thoroughly inspect the countertop and sink prior to installation to ensure there are no cracks, chips or visible damage. Confirm that all items required for installation are included in the kit.









Take accurate measurements of the area where the countertop with sink will be installed to ensure a perfect fit. Make sure that the measurements are compatible with the dimensions of the worktop and washbasin before proceeding with the installation.

Make sure that the surface where the countertop will be placed is level, clean and free of any debris. Check the location of the water and drainage outlets, making sure that they are correctly aligned with the sink connections.



To avoid any risk of the worktop tipping over it should be firmly anchored to the wall. Check the suitability and strength of the wall to ensure that it can support the weight and resist the forces at the fixings. Improper mounting may cause the worktop to fall and result in personal injury. If you are in any doubt about the installation, ask a specialist dealer or a professional.

THE KIRI	
MEASURE (MM)	WEIGHT (KG)
610x460x13	10
710x460x13	10,2
810x460 x13	12,4
910x460x13	13,6
1010x460x13	14,8
1110x460x13	16,04
1210x460x13	17,2
THE CHENEY	
700x460x110	15,2
800x460x110	16,8
1000x460x110	19,8
1200x460x110	22,6
1400x460x110	28,6
THE KIRI/CHENEY (Countertop)	
600x460x100	11,76
700x460x100	13,44
800x460x100	16,8
900x460x100	18,5
1000x460x100	20,16
1100x460x100	21,8
1200x460x100	23,5
THE KIRI/CHENEY (Floating Shelf)	
600x400x40	10,2
700x400x40	11,7
800x400x40	13,2
900x400x40	14,7
1000x400x40	16,2
1100x400x40	17,2
1200x400x40	19,2

Tools Required (not supplied):

Silicone and Adhesive PU (Polyurethane)		Gloves	
Measuring Tape		Spirit Level	
Screwdriver		Safety Glasses	
Drill		Hex Key	

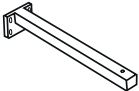
Component supplied for THE CHENEY, THE KIRI/CHENEY (countertop and floating self) INSTALLATION:

Brackets		Screw	
Wall Plug			

The product includes specific wall plugs and screws. If a different installation or support is required, it is recommended to purchase the appropriate components for that configuration. This will ensure a safe and efficient installation according to the specific needs.

THE KIRI INSTALLATION

1

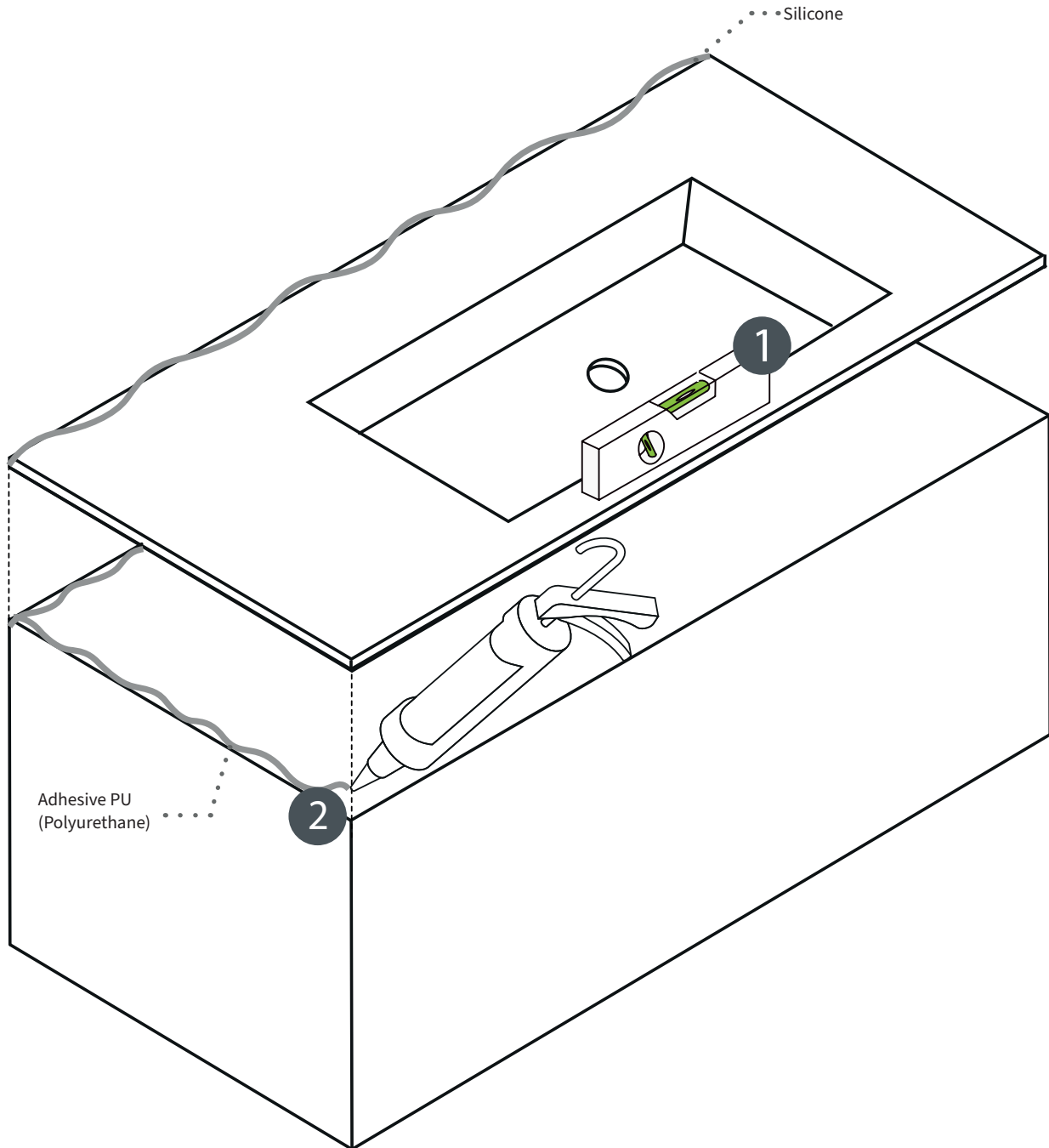

THE CHENEY INSTALLATION

1

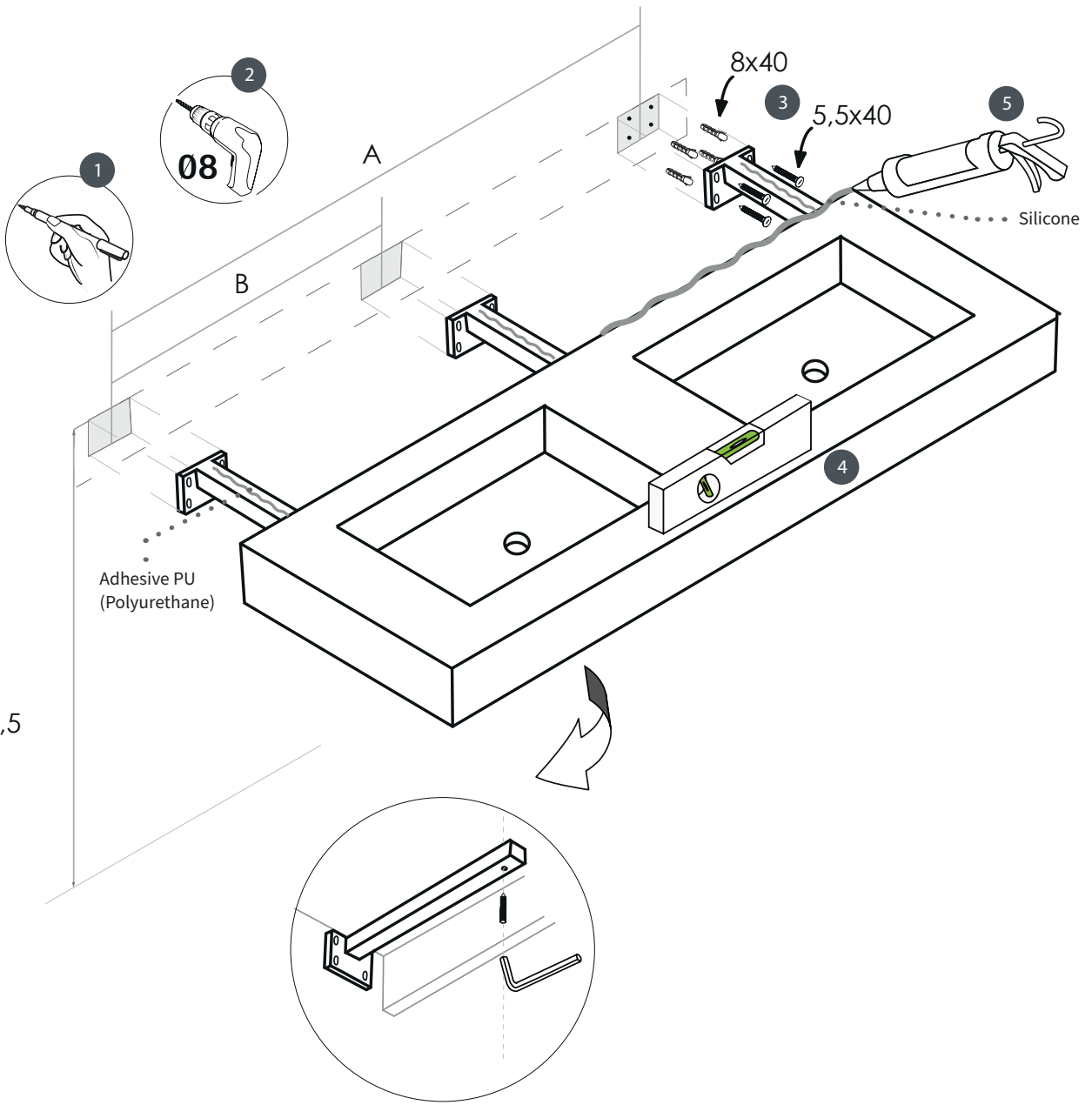

Adhesive PU
(Polyurethane)

86,5

70 cm	A: 57 cm
80 cm	A: 62 cm
100 cm	A: 75 cm
120 cm	A: 85 cm
140 cm	B: 63 cm

CARE & MAINTENANCE

Pay special attention to the product installation as any cement or mortar residue may damage it. In order to remove them, use a specific cement cleaner. Avoid rubbing the surface directly to avoid scratching it.

After every use, clean with water and ensure a good ventilation of the bathroom. For the routine cleaning, use water, liquid cleaners and soft cloths or non-abrasive sponges. Never use scourers or abrasive substances as they can damage the surface. Don't mix different cleaning products.

In order to remove limescale residues, use an antiscaling product following these steps:

1. - Apply the antiscaling product with the help of a damp cloth over the entire surface.
2. - Leave the product to act for 15 minutes, then rinse thoroughly.

If stains persist, after cleaning with soap and water, use cleaning vinegar diluted in water. In this case, repeat the above steps and let the product act for 5 minutes.

In case of stubborn stains, before applying the appropriate stain remover, clean the surface by rubbing with a plastic brush and rinse with plenty of water.

Pay special attention to the logo so gently clean it as it could be damaged.